



KING TONY

2012 PROMOTION

www.kingtony.ie



• Quality • Service • Reliability • Satisfaction •

The brand you can trust for life



KING TONY

Amazing Value.

€1699

Ex VAT



1/2" Drive Socket Set. 10-32mm



1/4" Dr. Socket Set 4-13mm



3/8" Dr. Socket Set. 6-22mm



Hex Bit Socket Set 4-17mm



1/2" Drive Torque Wrench



10" Grip Wrench



Pin Punch Set



Torx Bit Socket Set T20-T60



941-100MR

This Tool Kit Is Suitable For All Trades.

Comprehensive Sizes In All Kits Of The Most Popular General Hand Tools Normally Bought.

Supplied In A Heavy Duty 14 Drawer Storage System With Ball Bearing Drawer Slides And 5" Casters.

Large Storage Bin In The Roller Cabinet.

All The Tools You Need In One Handy Mobile Workstation!

Comprehensive Tool Kit



Filter Wrench Ball Hex Key Set



Flare Nut Wrench Set



Pliers Set



Impact Driver Set



Screwdriver Set



Hammer, Pliers & Adj Wrench Set



Ring Spanner Set 6-32mm



2 Way Hex Key Set 2-10mm



Combi - Wrench Set 6-32mm



Ratchet Spanner Set 8-19mm + Adapters.



2 Way Torx Key Set T10 - T50



File, Tape, Rule & Hacksaw Set.

ALL PRICES EXCLUDE VAT AND ARE SUBJECT TO AVAILABILITY • OFFER ENDS 31-12-2012

• Quality • Service • Reliability • Satisfaction •

The brand you can trust for life



KING TONY

Cantilever Tool Box Kit.

Heavy Duty Cantilever Tool Box.
 26Pc. 1/2" Drive Socket Set Containing Sizes From 10mm To 32mm.
 6Pc. IMPACT Type Screwdriver Set.
 3Pc. Plier Set.
 9Pc. Ball Ended Hex Key Set.
 Combination Spanners From 6mm ~ 24mm.
 Our Most Popular "Starter" Or "Engineers" Tool Box Kit.

€349



902-062MR

Cantilever Tool Box Kit

Advanced Tool Chest Kit.

6 Drawer King Tony Ball Bearing Tool Chest.

1/2" Drive Socket Set 10mm ~ 32mm.
 3/8" Drive Socket Set 6mm ~ 22mm.
 1/4" Drive Socket Set 4mm ~ 13mm.
 4 Piece Circlip Plier Set.
 LED Torch.
 Locking Pliers & Adjustable Pliers.
 3 Piece Pliers Set.
 10 Piece Screwdriver Set.
 Combination Wrench Set 6mm ~ 32mm.
 Chain Filter Wrench.
 9 Piece Metric Hex Key Set.

€749



911-118MR

Advanced Tool Chest Kit

219 Pc. Ultimate Tool Chest Kit.

6 Drawer King Tony Ball Bearing Tool Chest.
 Contains A Total Of 96 Sockets
 1/4", 3/8" & 1/2" Drive Metric & AF Sets
 Ranging From 4 ~ 32mm & From 5/32" ~ 1".
 4 Piece Circlip Plier Set.
 Ring Spanner Sets Metric & AF.
 Combination Spanner Sets Metric & AF.
 Open Ended Spanners Sets Metric & AF
 Chisels, Centre Punch & Pin Punches.
 Lock Grip Wrench & Adjustable Pliers.
 Engineers Hammer.
 Hex Key Sets Metric & AF.
 Adjustable Wrenches 8" & 12".
 10 Piece Screwdriver Set.
 3 Piece Plier Set.
 3 Piece Flare Nut Wrench Set.

€999



911-000CR

Ultimate Tool Chest Kit

ALL PRICES EXCLUDE VAT AND ARE SUBJECT TO AVAILABILITY • OFFER ENDS 31-12-2012

• Quality • Service • Reliability • Satisfaction •

The brand you can trust for life



KING TONY



€65

Cantilever Tool Box.

Heavy Duty Cantilever Tool Box.
W 470mm x D 220mm x H 260mm.
5 Compartments.
Tubular Adjustable Handle.
Shapes Pressed On Flat Surfaces To Reinforce The Steel.
Rubber Matting Included.
R.R.P. €79.90



87402

Cantilever Tool Box



€349

9 Drawer Tool Chest.

9 Drawer Ball Bearing Tool Chest.
W 660mm x D 307mm x H 427mm.
Heavy Gauge Steel.
Fold Down Locking System.
Rubber Matting Included.
Powder Coating Finish.

R.R.P. €439.00



87411-9B

9 Drawer Tool Chest



€199

3 Drawer Intermediate Tool Chest.

Ball Bearing Drawer Slides.
W 660mm x D 305mm x H 250mm.
Heavy Gauge Steel.
Central Locking System.
Rubber Matting Included.
Powder Coating Finish.

R.R.P. €225.00



87421-3B

3 Drawer Middle Tool Chest



€599

7 Drawer Tool Trolley.

Ball Bearing Drawer Slides.
W 670mm x D 460mm x H 812mm.
Frame Constructed With One Piece Steel Sheet For Integral Strength.
Central Locking System.
Rubber Matting Included.
Powder Coating Finish.
R.R.P. €795.00



87434-7B

7 Drawer Tool Cabinet

ALL PRICES EXCLUDE VAT AND ARE SUBJECT TO AVAILABILITY • OFFER ENDS 31-12-2012



KING TONY

26 Pc. 1/4" Drive Long & Short Socket Set.

Sockets Range From 4mm to 13mm.
 6 Point Sockets.
 2" & 4" Extension Bars.
 Universal Joint.
 1/4" Drive Ratchet Handle.
 3/8" M x 1/4" F Adapter.

€55



R.R.P. €64.90



2526MR

1/4" Drive Socket Set

26 Pc. 3/8" Drive Long & Short Socket Set.

Sockets Range From 7mm to 19mm.
 Short Sockets Are 12 Point.
 Deep Sockets are 6 Point.
 3/8" Drive Ratchet Handle.
 3" Extension Bar.
 Universal Joint.
 3/8" x 1/4" Reducer.
 R.R.P. €99.90

€79.90



3027MR

3/8" Drive Socket Set

24 Pc. 1/2" Drive Socket Set.

Sockets Range From 10mm to 32mm.
 6 Point Sockets.
 Patented Design On Ratchet Handle,
 L - Handle & Sliding T Bar.
 Adjustable Handle.
 21mm Spark Plug Socket.
 2" Wobble Extension Bar.
 R.R.P. €149.90

€120



4524MR

1/2" Drive Socket Set

24 Pc. 1/2" Drive Socket Set.

Sockets Range From 10mm to 32mm.
 12 Point Sockets.
 5" & 10" Extension Bars.
 Universal Joint.
 21mm Spark Plug Socket.
 1/2" Drive Ratchet Handle, Power Bar & Sliding T Bar.

€135



4032MR

1/2" Drive Socket Set

ALL PRICES EXCLUDE VAT AND ARE SUBJECT TO AVAILABILITY • OFFER ENDS 31-12-2012

• Quality • Service • Reliability • Satisfaction •

The brand you can trust for life



KING TONY



€199

42 Pc. 1/2" Drive Metric - Imperial Socket Set.

Sockets Range From 10mm to 32mm Metric and 5/16" to 1-1/4" Imperial.
21mm Spark Plug Socket.
18" Power Bar. Universal Joint.
1/2" Drive Ratchet Handle.
12" Sliding T Bar. 5" & 10" Extension Bars.
Blue Stripe = Metric. Red Stripe = Imperial.
R.R.P. €249.90

 **4042CR** 1/2" Drive Metric - AF Socket Set



€220

62 Pc. 1/4" + 3/8" + 1/2" Drive Socket Set.

4mm ~ 12mm 1/4" Drive Sockets.
8mm ~ 19mm 3/8" Drive Sockets.
12mm ~ 32mm 1/2" Drive Sockets.
12mm ~ 19mm 3/8" Drive Deep Sockets.
T20 ~ T40 3/8" Drive Torx Bit Sockets.
H4 ~ H10 3/8" Drive Hex Bit Sockets.
1/4", 3/8" & 1/2" Drive Accessories And Drivers.
R.R.P. €265.00

 **9063MR** 1/4", 3/8" & 1/2" Drive Socket Set



€249

16 Pc. 3/4" Drive Socket Set.

Sockets Range From 21mm to 50mm.
12 Point Sockets.
20" Ratchet.
Sliding T Bar.
8" & 16" Extension Bars.
In Steel Carry Case.

R.R.P. €275.00

 **6016MR** 3/4" Drive Socket Set



€575

14 Pc. 1" Drive Socket Set.

Sockets Range From 36mm to 80mm.
12 Point Sockets.
32" Ratchet.
Sliding T Bar.
8" & 16" Extension Bars.
In Steel Carry Case.

R.R.P. €680.00

 **8015MR** 1" Drive Socket Set

ALL PRICES EXCLUDE VAT AND ARE SUBJECT TO AVAILABILITY • OFFER ENDS 31-12-2012



KING TONY

8 Pc. 1/2" Drive Socket Set On Clip Rail.

Sockets Range From 10mm to 21mm.
12 Point Sockets.
230mm Socket Clip Rail With 8 Clips.

€19.90



R.R.P. €32.90



4010MR02

1/2" Drive Socket Set

11 Pc. 1/2" Drive Socket Set.

8 Sockets Range From 10mm to 19mm.
6 Point Sockets.
10" 1/2" Drive Ratchet Handle With Rubber Grip.
5" Extension Bar.
10" Sliding T Bar.

€49.90



R.R.P. €79.90



4311MR

1/2" Drive Socket Set

107 Pc. 1/4" + 3/8" + 1/2" Drive Socket Set.

4mm ~ 10mm 1/4" Drive Sockets.
6mm ~ 17mm 3/8" Drive Sockets.
8mm ~ 32mm 1/2" Drive Sockets.
E4 ~ E18mm 3/8" Drive Star Sockets.
T15 ~ T50 Torx Bits.
H3 ~ H12 Hex Bits.
8mm ~ 24mm Combination Wrenches.
8mm ~ 19mm Flare Nut Wrenches.
4" & 6" Flat Screwdrivers.
No.1 & No.2 Phillips Screwdrivers.
8" Adjustable Wrench.
6" Combination Pliers.
16mm & 21mm Spark Plug Sockets.
1/4", 3/8" & 1/2" Drive Ratchets.
1/4", 3/8" & 1/2" Drive Universal Joints.
1/4", 3/8" & 1/2" Drive Extension Bars.
1/2" Drive Wobble Extension Bar 2".
1/2" Drive 15" Power Bar.
1/2" Drive Socket Type Bit Holder For Hex & Torx Bits.

€399



A Complete Tool Kit In One Handy Carry Case!

R.R.P. €499.00



9507MR 1/4", 3/8" & 1/2" Drive Socket Set

ALL PRICES EXCLUDE VAT AND ARE SUBJECT TO AVAILABILITY • OFFER ENDS 31-12-2012

• Quality • Service • Reliability • Satisfaction •

The brand you can trust for life



KING TONY

NEW



€14.90



7 Pc. 1/4" Drive Hex Bit Socket Set On Clip Rail.

Sizes From H3 to H10.
130mm Socket Clip Rail With 7 Clips.

R.R.P. €19.90



2127PR

1/4" Drive Hex Bit Socket Set

NEW



€14.90



9 Pc. 1/4" Drive Torx Bit Socket Set On Clip Rail.

Sizes From T8 to T40.
150mm Socket Clip Rail With 9 Clips.
Suitable For Tamper Resistant Torx Screws.

R.R.P. €19.90



2119PR

1/4" Drive Torx Bit Socket Set

NEW



€19.90

17 Pc. Socket & Power Bit Set.

1/4" Drive Sockets Range From 4mm to 7mm.
Magnetic Type Quick Release Bit Holder.
4mm, 5.5mm & 6.5mm Flat Power Bits.
PH1, PH2 & PH3 Phillips Power Bits.
T10, T15 & T20 Torx Power Bits.
1/4" Drive Socket Drive Adaptor.

R.R.P. €29.90



2517MR

Socket & Power Bit Set

€29.90



12 Pc. 3/8" & 1/2" Drive Star Socket Set.

3/8" Drive Star Sockets From E4 ~ E8.
1/2" Drive Star Sockets From E10 ~ E20.
3/8" x 1/2"m Socket Adaptor.
3/8" Drive Sliding T Bar.
260mm Socket Clip Rail With 11 Clips.

R.R.P. €39.90



7112PR

1/2" + 3/8" Drive Star Socket Set

ALL PRICES EXCLUDE VAT AND ARE SUBJECT TO AVAILABILITY • OFFER ENDS 31-12-2012



KING TONY

5 Pc. 1/2" Drive Spline Bit Socket Set.

Sizes Range From M8 to M16.
150mm Socket Clip Rail With 5 Clips.
Bits Made From Silicon Alloy Steel (S2).



This Set Contains The Popular M16 Tamper Resistant Spline Socket As Used On Many Volkswagens.

R.R.P. €39.90



 4105PR 1/2" Drive Spline Bit Socket Set

9 Pc. 1/2" Drive Torx Bit Socket Set.

Sizes Range From T20 to T60.

Sockets Made From Chrome Vanadium Steel.
Bits Made From Silicon Alloy Steel (S2).
Packed In A Strong Steel Case.



R.R.P. €49.90



 4109PR 1/2" Drive Torx Bit Socket Set

9 Pc. 1/2" Drive Hex Bit Socket Set.

Sizes Range From H3 to H14.

Sockets Made From Chrome Vanadium Steel.
Bits Made From Silicon Alloy Steel (S2).
Packed In A Strong Steel Case.



R.R.P. €49.90



 4110PR 1/2" Drive Hex Bit Socket Set

44 Pc. 3/8" & 1/2" Drive Bit Socket Set.

Torx Bit Sizes Range From T20 to T60.
Hex Bit Sizes Range From H4 to H12.
Spline Bits Range From M5 to M12.
All Bits Come in 36mm and 80mm Long.
Bits Made From Silicon Alloy Steel (S2).
3/8" & 1/2" Drive Socket Type Bit Holders Included.
Packed In A Strong Steel Case.



R.R.P. €79.90



 1044CQ Hex, Spline & Torx Bit Set

ALL PRICES EXCLUDE VAT AND ARE SUBJECT TO AVAILABILITY • OFFER ENDS 31-12-2012

• Quality • Service • Reliability • Satisfaction •

The brand you can trust for life



KING TONY



€19.90

End Of Line Stock Clearance

Tuff Tools 3/8" Drive Ratchet.

72T Gear Mechanism.
Slim Design Ratchet Head.
Polished Handle.
R.R.P. €29.90

3765-08P



€19.90

TUFF TOOLS
IRELAND

Tuff Tools 3/8" Drive Ratchet.

72T Gear Mechanism.
Slim Design Ratchet Head.
Rubber Grip Handle.
R.R.P. €37.50

3795-08G



€34.90

1/2" Drive Telescopic Ratchet.

2 Piece 1/2" Drive King Tony Ratchet Set.
12" 1/2" Drive 45T Reversible Ratchet.
11" 1/2" Drive Adjustable Handle.
Both Items Can Be Used Independently.

Overall Length From 300mm to 540mm.

R.R.P. €42.90



4725-22G

Telescopic Ratchet



€25

1/2" Drive Reversible Ratchet.

32T Gear Mechanism.
Two Teeth Pawl Action.
Push Button Socket Release.
Rubber Grip.
Gear / Driver Made From Chrome Molybdenum Steel.
Handle Made From Chrome Vanadium Steel.

R.R.P. €37.50



4771-10G

1/2" Drive Ratchet



NEW

€25

18" Heavy Duty Power Bar 1/2" Drive.

NEW DESIGN Heavy Duty Head.
18" Long 450mm.
180 Degree Action.
Replaceable Swivel Heads Available.
DIN 3122.

R.R.P. €35.00



4462-18F

1/2" Drive Power Bar

ALL PRICES EXCLUDE VAT AND ARE SUBJECT TO AVAILABILITY • OFFER ENDS 31-12-2012



KING TONY

Replaceable Head For 1/2" Drive Power Bar.

Heavy Duty Design.
Fits Many Brands Of 1/2" Drive Power Bar.
Supplied With Spring And Screw.

€10



Replacement Part For King Tony 4462-18F & 4462-24F.

R.R.P. €14.90

 **4462DK** 1/2" Drive Power Bar Head

24" Heavy Duty Power Bar 1/2" Drive.

NEW DESIGN Heavy Duty Head.
24" Long 600mm.
180 Degree Action.
Replaceable Swivel Heads Available.
DIN 3122.

€39.90

NEW

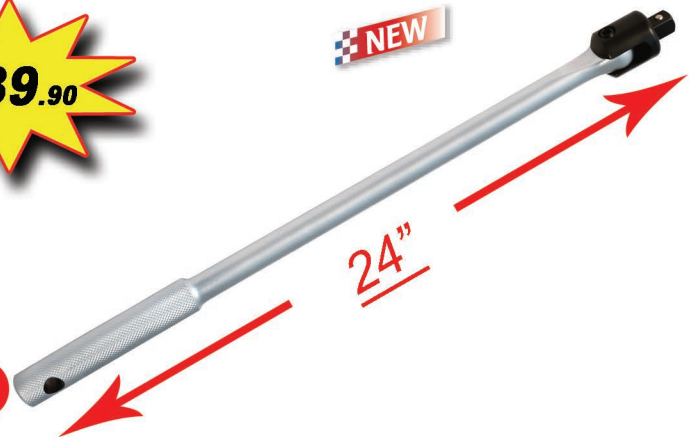

R.R.P. €49.90

 **4462-24F** 1/2" Drive Power Bar

3/4" Drive 90 Degree L Bar.

Chrome Vanadium Alloy Steel.
18" Long 450mm.
Chrome Plated.
Lifetime Guarantee.
DIN 3122.

€29.90



R.R.P. €39.90

 **6581-18** 3/4" Drive L Bar

3/4" Drive Sliding T Bar.

Chrome Vanadium Alloy Steel.
20" Long 500mm.
Chrome Plated.
Lifetime Guarantee.
DIN 3122.

€29.90

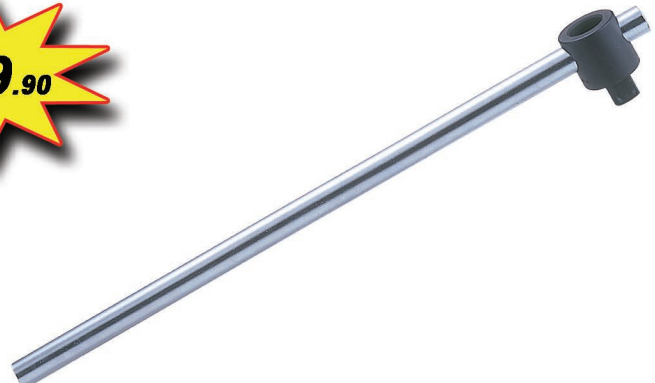

R.R.P. €39.90

 **6572-20** 3/4" Drive Sliding T Bar

ALL PRICES EXCLUDE VAT AND ARE SUBJECT TO AVAILABILITY • OFFER ENDS 31-12-2012

• Quality • Service • Reliability • Satisfaction •

The brand you can trust for life



KING TONY



€49.90

NEW



12 Pc. Stubby Combination Wrench Set.

Sizes Range From 8mm to 19mm Inclusive.
Short Pattern Design Enables Greater Access In Confined Spaces.
Chrome Vanadium Alloy Steel.
Packed In Durable Vinyl Pouch.
Lifetime Guarantee.

R.R.P. €64.90

 **1282MR Stubby Combination Wrench Set**



€99

14 Pc. Metric Combination Wrench Set.

Sizes Range From 10mm to 32mm.
European Slimline Design.
Chrome Vanadium Steel.
DIN 3113. ISO 7738.
Packed In Durable Vinyl Pouch.
Lifetime Guarantee.

R.R.P. €115.00

 **1214MR Metric Combination Wrench Set**

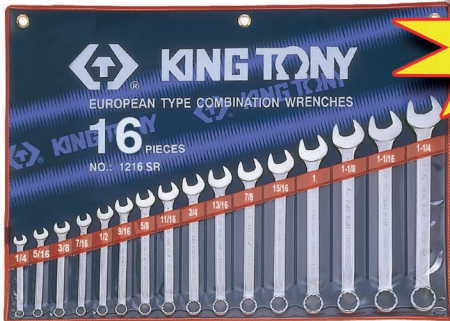

€110

NEW

16 Pc. Imperial Combination Wrench Set.

Sizes Range From 1/4" to 1-1/4".
European Slimline Design.
Chrome Vanadium Steel.
ANSI / ASME B107.6
Packed In Durable Vinyl Pouch.
Lifetime Guarantee.

R.R.P. €139.00

 **1216SR Imperial Combination Wrench Set**



€169

26 Pc. Metric Combination Wrench Set.

Sizes Range From 6mm to 32mm Inclusive.
European Slimline Design.
Chrome Vanadium Steel.
DIN 3113. ISO 7738.
Packed In Durable Vinyl Pouch.
Lifetime Guarantee.

R.R.P. €199.00

 **1226MR Metric Combination Wrench Set**

ALL PRICES EXCLUDE VAT AND ARE SUBJECT TO AVAILABILITY • OFFER ENDS 31-12-2012



KING TONY

10 Pc. Double Ended Ring Spanner Set.

Sizes Range From 6mm to 32mm.
 75 Degree Deep Ring Offset.
 European Slimline Design.
 Chrome Vanadium Steel.
 Packed In Durable Vinyl Pouch.
 Lifetime Guarantee.

€85



R.R.P. €105.00



1710MR

Ring Spanner Set

6 Pc. Double Swivel End Socket Wrench Set.

Sizes Include,
 8 x 9mm, 10 x 11mm, 12 x 13mm,
 14 x 15mm, 16 x 17mm & 18 x 19mm.
 Thin Wall Design On Socket Heads.
 Sockets Can Rotate Up To 180 Degrees.
 Chrome Vanadium Steel.

€89.90



R.R.P. €119.90



1A06MR

Swivel End Socket Wrench Set

13 Pc. Ratchet Spanner Set.

72T Fine Gear Ratchet Spanners.
 Sizes Include, 8mm, 10mm, 12mm,
 13mm, 14mm, 16mm,
 17mm, 18mm & 19mm.
 Includes 4pc. Adapter Set:
 1/4" Drive, 3/8" Drive & 1/2" Drive.
 Plus Bit Adapter For Power Bits.
 R.R.P. €149.90

€129



13113MR

Ratchet Spanner Set

Tuff Tools 5 Pc. Finger / Palm Ratchet Set.

10mm & 13mm 72T Finger Ratchets.
 Set Of Adapters Included
 To Convert The Finger Ratchets Into 1/4" Drive,
 3/8" Drive & Bit Driver Palm Ratchets.
 Extremely Useful For Awkward Tight Spaces.
 All Stored In A Pocket Sized Carry Case.

€19.90



End Of Line Stock Clearance



R.R.P. €39.90



2355PR

Finger / Palm Ratchet Set

ALL PRICES EXCLUDE VAT AND ARE SUBJECT TO AVAILABILITY • OFFER ENDS 31-12-2012

• Quality • Service • Reliability • Satisfaction •

The brand you can trust for life



KING TONY



€199

NEW

6 Pc. Jumbo Combination Wrench Set.

Sizes Include 34mm, 36mm, 38mm, 41mm, 46mm, 50mm.

Jumbo Type Raised Panel.

DIN 3113. ISO7738.

Packed In Heavy Duty Tetoron Pouch.

R.R.P. €250.00



1296MRN

Jumbo Spanner Set



€99

End Of Line Stock Clearance

Tuff Tools 55mm Combination Wrench.

European Slimline Design.

Chrome Vanadium Steel.

Lifetime Guarantee.

R.R.P. €135.00

TUFF TOOLS
IRELAND

1060-55



€125

Tuff Tools 60mm Combination Wrench.

European Slimline Design.

Chrome Vanadium Steel.

Lifetime Guarantee.

R.R.P. €179.00

TUFF TOOLS
IRELAND

1060-60



€175

End Of Line Stock Clearance

Tuff Tools 65mm Combination Wrench.

European Slimline Design.

Chrome Vanadium Steel.

Lifetime Guarantee.

R.R.P. €229.00

TUFF TOOLS
IRELAND

1060-65



€199

Tuff Tools 70mm Combination Wrench.

European Slimline Design.

Chrome Vanadium Steel.

Lifetime Guarantee.

R.R.P. €249.00

TUFF TOOLS
IRELAND

1060-70



€499

End Of Line Stock Clearance

Tuff Tools 4 Pc. Extra Large Spanner Set.

Sizes Include 55mm, 60mm, 65mm & 70mm.

European Slimline Design.

Chrome Vanadium Steel.

Lifetime Guarantee.

R.R.P. €750.00

TUFF TOOLS
IRELAND

1294MR01

Extra Large Spanner Set

ALL PRICES EXCLUDE VAT AND ARE SUBJECT TO AVAILABILITY • OFFER ENDS 31-12-2012



KING TONY

6 Pc. Screwdriver Set.

SNCM + V Alloy Steel Round Shank.
 No. 0 x 60mm
 No. 1 x 80mm
 No. 2 x 100mm
 3 x 75mm
 5.5 x 100mm
 6.5 x 150mm
 R.R.P. €31.00

€20



31116MR

Screwdriver Set

6 Pc. Impact Type Screwdriver Set.

SNCM + V Alloy Steel Hex Shank.
 No. 1 x 75mm
 No. 2 x 100mm
 No. 3 x 150mm
 5.5 x 100mm
 6.5 x 150mm
 8 x 175mm
 R.R.P. €52.50

€39.90



30206MR

Heavy Duty Screwdriver Set

7 Pc. Tamper Type Torx Screwdriver Set.

SNCM + V Alloy Steel Round Shank.
 Suitable For Tamper Type Torx Head Screws.
 Sizes Include,
 T10, T15, T20, T25, T27, T30 & T40.

€34.90



R.R.P. €42.50

30307PR

Torx Screwdriver Set

10 Pc. Reversible Ratchet Screwdriver Set.

16 Sizes Included.
 Flat Sizes, 4mm, 5mm, 6mm & 8mm.
 Phillips Sizes, PH0, PH1, PH2, PH3.
 Hex Sizes, H2, H2.5, H3, H4, H5 & H6.
 Torx Sizes, T10 & T15.
 1/2" & 5/16" Bit Holders To Drive Various Types Of Bits.

€24.90



R.R.P. €39.90

32810MR

Ratchet Screwdriver Set

ALL PRICES EXCLUDE VAT AND ARE SUBJECT TO AVAILABILITY • OFFER ENDS 31-12-2012

• Quality • Service • Reliability • Satisfaction •

The brand you can trust for life



KING TONY



€9.90

10 Pc. Screwdriver Power Bit Set.

Sizes Include,
PH1, PH2 & PH3.
PZ1, PZ2 & PZ3.
Flat 4.5mm, 5.5mm & 6.5mm.
Magnetic Bit Holder.
Packed In Steel Carry Case.

R.R.P. €17.90



1010MQ01

Screwdriver Bit Set



NEW

€3

3 Pc. Phillips Head Power Bit Set.

25mm Length.
PH1, PH2 & PH3.
S2 Steel.
R.R.P. €3.90



1003PQ



€3

3 Pc. Pozidriv Head Power Bit Set.

25mm Length.
PZ1, PZ2 & PZ3.
S2 Steel.
R.R.P. €3.90



1003ZQ



NEW

€3

3 Pc. Torx Head Power Bit Set.

25mm Length.
T8, T10 & T15.
S2 Steel.
R.R.P. €3.90



1003TQ



€3

3 Pc. Torx Head Power Bit Set.

25mm Length.
T20, T25 & T30.
S2 Steel.
R.R.P. €3.90



1003TQ01



NEW

€3

3 Pc. Hex Head Power Bit Set.

25mm Length.
H4, H5 & H6.
S2 Steel.
R.R.P. €3.90



1003MQ



€3

3 Pc. Flat Head Power Bit Set.

25mm Length.
4.5 x 0.6, 6.5 x 1.2, 8.0 x 1.2mm.
S2 Steel.
R.R.P. €3.90



1003LQ



ALL PRICES EXCLUDE VAT AND ARE SUBJECT TO AVAILABILITY • OFFER ENDS 31-12-2012



KING TONY

7 Pc. Metric Ball Ended Hex Key Set.

Sizes Include,
 2.5mm, 3mm, 4mm,
 5mm, 6mm, 8mm, 10mm.
 Made From SNCM + V Alloy Steel.
 Chrome Plated.
 DIN ISO 2936.
 Lifetime Guarantee.
 R.R.P. €16.90

€13.90

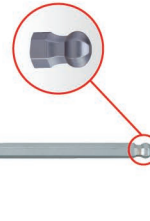

20107MR01

Metric Hex Key Set

7 Pc. Imperial Ball Ended Hex Key Set.

Sizes Include,
 3/32", 1/8", 5/32", 3/16", 1/4", 5/16" & 3/8".
 Made From SNCM + V Alloy Steel.
 Chrome Plated.
 DIN ISO 2936.
 Lifetime Guarantee.

R.R.P. €16.90

€13.90

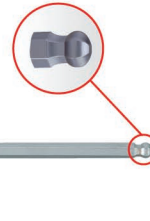

20107SR

Imperial Hex Key Set

9 Pc. X - Long Metric Ball Ended Hex Key Set.

Sizes Include,
 1.5mm, 2mm, 2.5mm, 3mm,
 4mm, 5mm, 6mm, 8mm & 10mm.
 Made From SNCM + V Alloy Steel.
 Chrome Plated.
 DIN ISO 2936.
 Lifetime Guarantee.
 R.R.P. €24.90

€17.90



20109MR

Metric Hex Key Set

9 Pc. Extra Long Tamper Type Torx Key Set.

Sizes Include,
 T10, T15, T20, T25,
 T27, T30, T40, T45 & T50.
 Made From SNCM + V Alloy Steel.
 Chrome Plated.
 Lifetime Guarantee.

R.R.P. €29.90

€19.90



20419PR

Torx Key Set

ALL PRICES EXCLUDE VAT AND ARE SUBJECT TO AVAILABILITY • OFFER ENDS 31-12-2012

• Quality • Service • Reliability • Satisfaction •

The brand you can trust for life



KING TONY

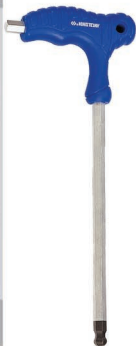

€29.90

6 Pc. L Type Hex Key Set.

Sizes Include,
3mm, 4mm, 5mm, 6mm, 7mm & 8mm.
Made From SNCM + V Alloy Steel.
Ball Ended On Long End.

R.R.P. €44.00



22106MR

L Type Hex Key Set



€29.90

6 Pc. L Type Torx Key Set.

Sizes Include,
T10, T15, T20, T25, T30 & T40.
Made From SNCM + V Alloy Steel.
Tamper Resistant Type On Short End.

R.R.P. €44.00



22306PR

L Type Torx Key Set



€55

4 Pc. Circlip Plier Set.

Internal, External, Bent & Straight.
7" Pliers.
All With Return Spring.
Packed In Heavy Duty Vinyl Pouch.

R.R.P. €67.50



42114GP

Circlip Plier Set



€89.90

6 Pc. Circlip Plier Set.

Includes 7" Internal, External, Bent & Straight Circlip Pliers.
Also Includes,
10" Internal & External Straight Circlip Pliers.
All With Return Spring.
Packed In Heavy Duty Vinyl Pouch.

R.R.P. €117.50



42116GP

Circlip Plier Set

ALL PRICES EXCLUDE VAT AND ARE SUBJECT TO AVAILABILITY • OFFER ENDS 31-12-2012



KING TONY

Tuff Tools 6" Long Nose Pliers.

Industrial Quality.
Polished Heads.
Heat Treated.
Chrome Vanadium Steel.

€15

End Of Line Stock Clearance

R.R.P. €17.90



6312-06

6" Long Nose Pliers



Tuff Tools 8" Long Nose Pliers.

Industrial Quality.
Polished Heads.
Heat Treated.
Chrome Vanadium Steel.

€15

End Of Line Stock Clearance

R.R.P. €18.90



6312-08

8" Long Nose Pliers



Tuff Tools 8" Combination Pliers.

Industrial Quality.
Polished Heads.
Heat Treated.
Chrome Vanadium Steel.

€15

End Of Line Stock Clearance

R.R.P. €18.90



6112-08

8" Combination Pliers



Tuff Tools 8" Heavy Duty Side Cutting Pliers.

Industrial Quality.
Polished Heads.
Heat Treated.
Chrome Vanadium Steel.

€15

End Of Line Stock Clearance

R.R.P. €18.90



6232-08

8" Side Cutting Pliers



ALL PRICES EXCLUDE VAT AND ARE SUBJECT TO AVAILABILITY • OFFER ENDS 31-12-2012

• Quality • Service • Reliability • Satisfaction •

The brand you can trust for life



KING TONY



€7.50

Miniature Long Nose Pliers 5".

Overall Length 134mm 5-1/4".
Grip Material - PP + TPR.
DIN ISO 5745
Cutting Capacity, Soft Wire 3.0mm,
Medium Hard Wire 2.0mm,
Hard Wire 1.6mm.

R.R.P. €12.90



6314-05

Mini Long Nose Pliers



€7.50

Miniature Combination Pliers 5".

Overall Length 140mm 5-1/2".
Grip Material - PP + TPR.
DIN ISO 5745
Cutting Capacity, Soft Wire 3.0mm,
Medium Hard Wire 2.0mm,
Hard Wire 1.6mm.

R.R.P. €12.90



6114-05

Mini Combination Pliers



€9.90

Tuff Tools 5" Mini Locking Pliers.

5" Mini Grips With Wire Cutters.
Industrial Quality.
Chrome Molybdenum Alloy Steel.
Lifetime Guarantee.

End Of Line Stock Clearance

R.R.P. €15.50

TUFF TOOLS
IRELAND

6015-05

Mini Locking Pliers



€12.50

King Tony 10" Lock Grip Pliers.

Industrial Quality.
Chrome Molybdenum Alloy Steel.
Straight Jaw.
Jaw Width 10mm.
Jaw Length 30mm.
Jaw Capacity 45mm.
Lifetime Guarantee.
R.R.P. €15.50



6031-10

10" Locking Pliers

ALL PRICES EXCLUDE VAT AND ARE SUBJECT TO AVAILABILITY • OFFER ENDS 31-12-2012



KING TONY

Tuff Tools 1/2" Drive Air Ratchet.

1/2" Drive.
 60 FT/LBS Torque.
 Hardened Gears For Longer Life.
 Ideal For Maintenance Or Assembly
 In Confined Spaces.
 Quick Release Button Enables Fast Socket Changes.

€69.90



R.R.P. €95.00

End Of Line Stock Clearance

37410-060

1/2" Drive Air Ratchet



Tuff Tools 1" Drive Impact Wrench.

1800 FT/LBS Torque.
 Twin Hammer Mechanism.
 Long Shank.
 Common Applications Include, Tyre Depots,
 Heavy Automotive, Agriculture, Trucks & Trailers.

€499



R.R.P. €875.00

End Of Line Stock Clearance

33810-180L

1" Drive Air Gun



19.2V Cordless 1/2" Drive Impact Wrench Set.

2 x 19.2V Ni-Cd Battery Packs.
 1/2" Square Drive.
 1 Hour Charger.
 310Nm Torque.
 Auxiliary Handle.

€399

NEW

Interchangeable Carbon Brushes
 To Extend Motor's Life.

LED Light Indicator, Side Handle & Ergonomic Grip
 For Comfort And Ease of Use.

Safety Feature -
 Thermostat Controller Stops The Motor Automatically
 When The Temperature Reaches 70 Degrees C.

R.R.P. €599.00



Cordless Impact Wrench



2.0AH Ni-Cd Battery Pack x 2



1HR Charger



Auxiliary Handle

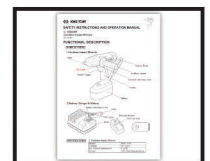

Safety Instructions & Operating Manual

44504MP

Cordless Impact Wrench Set

ALL PRICES EXCLUDE VAT AND ARE SUBJECT TO AVAILABILITY • OFFER ENDS 31-12-2012

• Quality • Service • Reliability • Satisfaction •

The brand you can trust for life



KING TONY



€199

NEW

Mini Design Wrench

1/2" Drive Impact Wrench Super Mini Design.

Industrial Quality 1/2" Drive Air Gun.
Super Mini Design.
450 ft/lbs Torque 610 Nm.
Twin Hammer Mechanism.
Two Step Speed On Trigger.
Overall Length 125mm, Only 1.6kg

R.R.P. €299.00 + €39.90 = €338.90

+

FREE Socket Set.

-30% length

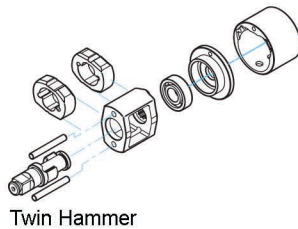

17mm, 19mm, 21mm, 22mm, 24mm



33451-045

Mini 1/2" Drive Air Gun

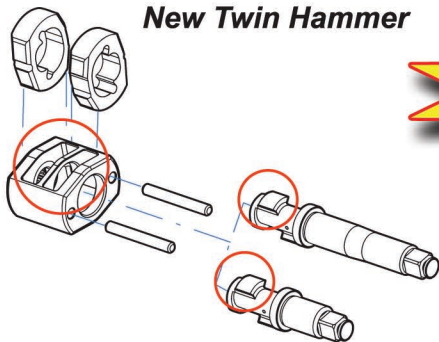

€249

1/2" Drive Impact Wrench.

Industrial Quality 1/2" Drive Air Gun.
650 ft/lbs Torque 881Nm.
New Twin Hammer Mechanism.
Variable Speed On Trigger.
Muffled Exhaust On Handle.

This is one of the most reliable and durable impact wrenches available on the market today!

R.R.P. €329.00 + €39.90 = €368.90

+

FREE Socket Set.



33411-050

1/2" Drive Air Gun

ALL PRICES EXCLUDE VAT AND ARE SUBJECT TO AVAILABILITY • OFFER ENDS 31-12-2012



KING TONY

3/4" Drive Impact Wrench Mini Design.

Industrial Quality 3/4" Drive Air Gun.
 Mini Design. Same Size Body As 1/2" Air Gun.
 700 ft/lbs Torque 949Nm.
 New Twin Hammer Mechanism.
 Variable Speed On Trigger.
 Muffled Exhaust On Handle.

€299

NEW



R.R.P. €429.00

New Twin Hammer !!

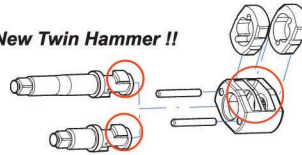

33611-055

Mini 3/4" Drive Air Gun

3/4" Drive Impact Wrench.

Industrial Quality 3/4" Drive Air Gun.
 800 ft/lbs Torque 1,085Nm.
 New Twin Hammer Mechanism.
 Variable Speed On Trigger.
 Muffled Exhaust On Handle.

€399



R.R.P. €505.00

33621-075

3/4" Drive Air Gun

1" Drive Light Weight Impact Wrench.

Industrial Quality 1" Drive Air Gun Short Shank.
 2,000 ft/lbs Torque 2,712Nm.
 Twin Hammer Mechanism.
 30% Shorter.
 35% Lighter.
 Only 7.1kg

€899

NEW



R.R.P. €1,250.00

33861-200

1" Drive Short Shank Air Gun

1" Drive Light Weight Impact Wrench.

Industrial Quality 1" Drive Air Gun Long Shank.
 2,000 ft/lbs Torque 2,712Nm.
 Twin Hammer Mechanism.
 30% Shorter.
 35% Lighter.
 Only 8.1kg

€899

NEW



R.R.P. €1,250.00

33862-200

1" Drive Long Shank Air Gun

ALL PRICES EXCLUDE VAT AND ARE SUBJECT TO AVAILABILITY • OFFER ENDS 31-12-2012

• Quality • Service • Reliability • Satisfaction •

The brand you can trust for life



KING TONY



€32.50

8 Pc. 1/2" Drive Impact Socket Set.

Socket Sizes Include:
10mm, 12mm, 13mm,
14mm, 17mm, 19mm,
21mm & 24mm.

Chrome Molybdenum Alloy Steel.
In Steel Carry Case.

R.R.P. €39.90



4408MP

1/2" Drive Impact Socket Set



€99

15 Pc. 1/2" Drive Deep Impact Socket Set.

Socket Sizes Include:
10mm, 11mm, 12mm, 13mm,
14mm, 15mm, 16mm, 17mm,
19mm, 21mm, 22mm, 24mm,
27mm, 30mm, & 32mm.

Chrome Molybdenum Alloy Steel.

R.R.P. €125.00



4415MP03

1/2" Drive Impact Socket Set



€99

11 Pc. 3/4" Drive Impact Hex Bit Socket Set.

Sizes Include:
10mm, 12mm, 14mm,
17mm, 19mm, 22mm,
24mm, 27mm & 32mm.

Chrome Molybdenum Alloy Steel.
In Steel Carry Case.

R.R.P. €135.00



6411MP

3/4" Drive Impact Hex Bit Set



€29.90

Mighty Seven Air Lubricator.

50c.c. Lubricating Oil Bowl Capacity.
Can Be Filled Under Pressure.

3/8" Air Inlet.

R.R.P. €39.90



SV-1310

€49.90

Mighty Seven Air Filter - Regulator.

Removes All Dirt Particles Larger Than Five Microns.

3/8" Air Inlet.

R.R.P. €69.90



SV-1320

ALL PRICES EXCLUDE VAT AND ARE SUBJECT TO AVAILABILITY • OFFER ENDS 31-12-2012



KING TONY

8 Pc. 3/4" Drive Impact Socket Set.

Sizes Include:
19mm, 22mm, 24mm,
27mm, 30mm, 32mm,
36mm & 38mm,

Chrome Molybdenum Alloy Steel.

R.R.P. €105.00

€85



 **6408MP** 3/4" Drive Impact Socket Set

8 Pc. 3/4" Drive Deep Impact Socket Set.

Socket Sizes Include:
27mm, 29mm, 30mm,
32mm, 33mm, 34mm,
36mm & 38mm.

Chrome Molybdenum Alloy Steel.

R.R.P. €145.00

€115



 **6410MP01** 3/4" Drive Impact Socket Set

8 Pc. 1" Drive Impact Socket Set.

Socket Sizes Include:
24mm, 27mm, 30mm,
32mm, 33mm, 36mm,
38mm & 41mm.

Chrome Molybdenum Alloy Steel.

R.R.P. €135.00

€115



 **8410MP** 1" Drive Impact Socket Set

8 Pc. 1" Drive Deep Impact Socket Set.

Socket Sizes Include:
24mm, 27mm, 30mm,
32mm, 33mm, 36mm,
38mm & 41mm.

Chrome Molybdenum Alloy Steel.

R.R.P. €299.00

€199



 **8409MP** 1" Drive Impact Socket Set

ALL PRICES EXCLUDE VAT AND ARE SUBJECT TO AVAILABILITY • OFFER ENDS 31-12-2012

• Quality • Service • Reliability • Satisfaction •

The brand you can trust for life



KING TONY

€49.90



1/4" Drive Professional Series Torque Wrench.

Torque Range: 25 ~ 250 in.lb. / 2.8 ~ 28.2 Nm
Increments: 1.5 in.lb. / 0.17 Nm
Torque Tolerance of 4%
Total Length: 280mm
Certificate Of Calibration Included.

R.R.P. €64.90



34223-1C

1/4" Drive Torque Wrench

€49.90



3/8" Drive Professional Series Torque Wrench.

Torque Range: 5 ~ 80 ft.lb. / 6.8 ~ 108.5 Nm
Increments: 0.5 ft.lb. / 0.68 Nm
Torque Tolerance of 4%
Total Length: 370mm
Certificate Of Calibration Included.

R.R.P. €69.90



34323-2C

3/8" Drive Torque Wrench

€54.90



1/2" Drive Professional Series Torque Wrench.

Torque Range: 10 ~ 150 ft.lb. / 13.6 ~ 203.4 Nm
Increments: 1 ft.lb. / 1.35 Nm
Torque Tolerance of 4%
Total Length: 450mm
Certificate Of Calibration Included.

R.R.P. €75.00



34423-1C

1/2" Drive Torque Wrench

€84.90



1/2" Drive Professional Series Torque Wrench.

Torque Range: 30 ~ 250 ft.lb. / 40.7 ~ 339 Nm
Increments: 2 ft.lb. / 2.71 Nm
Torque Tolerance of 4%
Total Length: 570mm
Certificate Of Calibration Included.

R.R.P. €125.00



34423-2C

1/2" Drive Torque Wrench

ALL PRICES EXCLUDE VAT AND ARE SUBJECT TO AVAILABILITY • OFFER ENDS 31-12-2012



KING TONY

1/2" Drive Digital Torque Adapter.

Torque Range:
 40 ~ 200 Nm. / 29.5 ~ 147.5 ft.lb / 4.08 ~ 20.38 kgf.m
 Torque Tolerance of 2%
 Operation Mode: Peak / Track.
 LED Indicator: Green. Yellow. Red.
 Overload Alarm: 250 Nm. / 184.4 ft.lb

R.R.P. €99.00



 **34407-1A** Digital Torque Adapter

1/2" Drive Industrial Series Torque Wrench.

Torque Range: 60 ~ 340 Nm. / 51.6 ~ 243.4 ft.lb
 Increments: 2 Nm. / 1.5 ft/lb
 Torque Tolerance of 3%
 Suitable For Clockwise / Counter Clockwise Operation
 Total Length: 613mm
 Certificate Of Calibration Included.

R.R.P. €179.00



 **34462-2FG** 1/2" Drive Torque Wrench

3/4" Drive Industrial Series Torque Wrench.

Torque Range:
 100 ~ 600 Nm.
 Increments: 5 Nm.
 Torque Tolerance of 3%
 Suitable For Clockwise / Counter Clockwise Operation.
 Total Length: 1048mm
 Certificate Of Calibration Included.
 R.R.P. €599.00



 **34662-1DG** 3/4" Drive Torque Wrench

1" Drive Industrial Series Torque Wrench.

Torque Range:
 200 ~ 1000 Nm.
 Increments: 5 Nm.
 Torque Tolerance of 3%
 Suitable For Clockwise / Counter Clockwise Operation.
 Total Length: 1238mm
 Certificate Of Calibration Included.
 R.R.P. €675.00



 **34862-1DG** 1" Drive Torque Wrench

ALL PRICES EXCLUDE VAT AND ARE SUBJECT TO AVAILABILITY • OFFER ENDS 31-12-2012

• Quality • Service • Reliability • Satisfaction •

The brand you can trust for life



€25

6 Pc. Pin Punch Set.

Sizes Include,
2mm, 3mm, 4mm,
5mm, 6mm & 8mm.
Chrome Vanadium Alloy Steel.

R.R.P. €32.00

 1006PR Pin Punch Set



€50

9 Pc. Pin Punch Set.

Sizes Include,
2mm, 3mm, 4mm,
5mm, 6mm, 8mm,
10mm, 12mm & 14mm.
Chrome Vanadium Alloy Steel.
Contains Extra Large Sizes Normally Not Available.

R.R.P. €64.90

 1009PR Pin Punch Set



€50

7 Pc. Steel Chisel Set.

Sizes Include,
13 x 100mm. 15 x 125mm. 17 x 150mm.
20 x 175mm. 23 x 200mm. 24 x 250mm.
26 x 300mm.
Chrome Vanadium Alloy Steel.

R.R.P. €65.00

 1007PR **NEW** Steel Chisel Set



€55

5 Pc. 10" File Set.

Ergonomic Grips For Added Comfort.
Flat, Round, Half Round,
Square & Triangle Files Included.

R.R.P. €67.90

 1015GQ File Set

ALL PRICES EXCLUDE VAT AND ARE SUBJECT TO AVAILABILITY • OFFER ENDS 31-12-2012



KING TONY

Heavy Duty Rivet Gun.

Capacity 4.8mm.
Aluminium Body.
Overall Length 260mm.
Nose Pieces Include: 2.4mm, 3.2mm,
4.0mm & 4.8mm.

€19.90



R.R.P. €25.90



21-20-101

Rivet Gun

5 Pc. Screw Extractor Set.

Quick And Easy Way To Remove Broken
Screws, Studs & Bolts.

1/8" - 1/4"
1/4" - 5/16"
5/16" - 7/16"
7/16" - 9/16"
9/16" - 3/4"

R.R.P. €14.90

€9.90

NEW



11205SQ

Screw Extractor Set

5m Magnetic Measuring Tape.

ABS Body.
Magnetic Hook On Blade.
Side & Bottom Lock Button.
Metric & Inch Readings.

€5.90



R.R.P. €8.90



79084-05C

Measuring Tape

4 Pc. Pry Bar Set.

Chrome Vanadium Alloy Steel.
PP + TPR Handles.
Sturdy Blade Minimizing Lever Spring Effect.
Hardened & Tempered For Maximum Durability.
Sizes Include:
8", 12", 18" & 24".

€50

NEW



R.R.P. €69.90



9TK014

Pry Bar Set

ALL PRICES EXCLUDE VAT AND ARE SUBJECT TO AVAILABILITY • OFFER ENDS 31-12-2012

• Quality • Service • Reliability • Satisfaction •

The brand you can trust for life



KING TONY

NEW



€120

4" Steel Bench Vice With Swivel Base.

Cast Steel Body & Slide,
Ideal For Heavy Duty Applications.
360 Degree Swivel Base.
Serrated Jaws Provide Good Grip.
Jaw Opening: 4" / 100mm.
Throat Depth: 2-1/4".

R.R.P. €149.90



9TZ11-04

4" Steel Vice

NEW



€149

5" Steel Bench Vice With Swivel Base.

Cast Steel Body & Slide,
Ideal For Heavy Duty Applications.
360 Degree Swivel Base.
Serrated Jaws Provide Good Grip.
Jaw Opening: 5" / 125mm.
Throat Depth: 2-5/8".

R.R.P. €195.00



9TZ11-05

5" Steel Vice

NEW



€199

6" Steel Bench Vice With Swivel Base.

Cast Steel Body & Slide,
Ideal For Heavy Duty Applications.
360 Degree Swivel Base.
Serrated Jaws Provide Good Grip.
Jaw Opening: 6" / 150mm.
Throat Depth: 3".

R.R.P. €249.90



9TZ11-06

6" Steel Vice

NEW



€250

8" Steel Bench Vice With Swivel Base.

Cast Steel Body & Slide,
Ideal For Heavy Duty Applications.
360 Degree Swivel Base.
Serrated Jaws Provide Good Grip.
Jaw Opening: 8" / 200mm.
Throat Depth: 3-1/2".

R.R.P. €349.90



9TZ11-08

8" Steel Vice

ALL PRICES EXCLUDE VAT AND ARE SUBJECT TO AVAILABILITY • OFFER ENDS 31-12-2012



KING TONY

18" Flexible Magnetic Pickup Tool.

Enhanced Flexible Conduit For Perfect Shaping.
More Powerful Magnetizing Force.
The Handle Is The Same as King Tony's Award Wining Screwdriver Handle.

€7.50

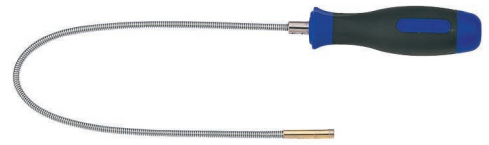

R.R.P. €11.90

 2121-18 **Magnetic Pickup Tool**

18" Magnetic Pickup Tool.

Compact & Ergonomic Design For Comfortable Use.
Comfortable Pushing Strength.
Magnetic Power 1.5kg
Enhanced Flexible Conduit For Perfect Shaping.

€15.90



R.R.P. €19.90

 2124-18 **Magnetic Pickup Tool**

24" 3 in 1 Pickup Tool.

Compact & Ergonomic Design For Comfortable Use.
1kg Powerful Magnet.
Hook Type Claw.
Clamp Light.
Enhanced Flexible Conduit For Perfect Shaping.

€25



R.R.P. €32.90

 2129-24 **3 in 1 Pickup Tool**

150mm Round Magnetic Dish.

Stainless Steel Dish Resists Corrosion.
Convenient For Collecting Small Parts & Tools.
Rubber Coated Back To Prevent Scratching On The Work Surface.
Foldable Plastic Tray For Collecting Non-Magnetic Parts.
R.R.P. €14.90

€9.90



 9TE11 **Magnetic Dish**

ALL PRICES EXCLUDE VAT AND ARE SUBJECT TO AVAILABILITY • OFFER ENDS 31-12-2012

• Quality • Service • Reliability • Satisfaction •

The brand you can trust for life



KING TONY



NEW



€8.90

20 Blade Metric Feeler Gauge.

Sizes Include,
0.05, 0.10, 0.15, 0.20, 0.25, 0.30,
0.35, 0.40, 0.45, 0.50, 0.55, 0.60,
0.65, 0.70, 0.75, 0.80, 0.85, 0.90,
0.95 & 1.00mm
Blade Size: 10 x 100mm

R.R.P. €12.50



77340-20

Metric Feeler Gauge



€7.90



79900-04

4" Blow Gun.

High Pressure Nozzle.
Sure Grip Design.
R.R.P. €11.50

€9.90



79900-10

10" Blow Gun.

High Pressure Nozzle.
Sure Grip Design.
R.R.P. €14.90

€14.90



79900-20

20" Blow Gun.

High Pressure Nozzle.
Sure Grip Design.
R.R.P. €19.50



€15.90

Curved Hose Clamp Pliers.

Designed To Remove & Install Flat Band Hose Clamps
In Hard To Reach Areas.
18 ~ 53mm Diameter.
Locking Latch Securely Holds Clamp In Position.
45 Degree Head Is Designed To Reach Clamps That
Are Recessed In Awkward Places.

R.R.P. €19.90



9AA21

Curved Hose Clamp Pliers

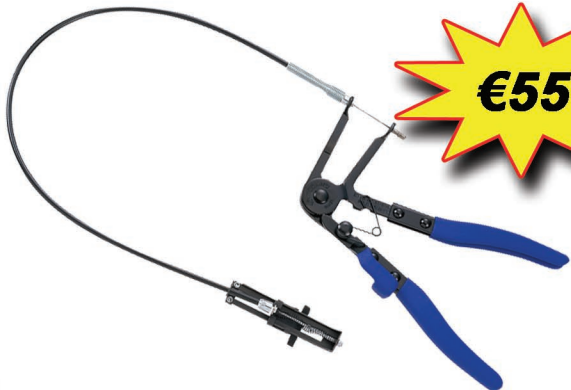

€55

Flexible Hose Clamp Pliers.

For Replacement Of Fuel, Oil & Water Hoses.
630mm Flexible Wire.
12 ~ 53mm Diameter.
Convenient For Working In Hidden Areas And Hard To
Reach Places.

R.R.P. €69.90



9AA31

Flexible Hose Clamp Pliers

ALL PRICES EXCLUDE VAT AND ARE SUBJECT TO AVAILABILITY • OFFER ENDS 31-12-2012



KING TONY

3 Leg Oil Filter Wrench.

Round Leg Type.
For Removing Oil Filters From
2-1/2" ~ 4-3/4", 63mm ~ 120mm In Diameter.
Suitable For Use With 1/2" or 3/8" Drive Tools.

€15.90



R.R.P. €19.90



9AE41

Oil Filter Wrench

3 Leg Oil Filter Wrench.

Flat Leg Claw Type.
For Removing Oil Filters From
2-1/2" ~ 4", 63mm ~ 102mm In Diameter.
Suitable For Use With 1/2" or 3/8" Drive Tools.

€15.90



R.R.P. €19.90



9AE42

Oil Filter Wrench

10 Pc. Valve Spring Compressor Set.

Complete Service Tool Kit For OHV & OHC
Petrol or Diesel Engines.

€120



R.R.P. €149.00



9AH11

Valve Spring Compressor Set

Universal Clutch Aligner Set.

Designed For The Alignment & Assembly Of
Clutches.
Specially Designed For Those Vehicles
Equipped With Late Model Front Wheel Drives
Without Pilot Bearing In Flywheel.

€16.50



R.R.P. €19.90



9AK11

Clutch Aligning Kit

ALL PRICES EXCLUDE VAT AND ARE SUBJECT TO AVAILABILITY • OFFER ENDS 31-12-2012

• Quality • Service • Reliability • Satisfaction •

The brand you can trust for life



KING TONY



V-Belt Pulleys



€25

Pulley Removing Wrench.

For V Belt Pulleys.
To Lock The Pulley During Removing Or Assembling
Any Type Of Pulley Retaining Bolt.
Diameter: 40 ~ 140mm.



R.R.P. €31.50



9AL11

Pulley Removing Wrench

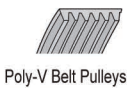

Poly-V Belt Pulleys



€35.90

Pulley Removing Wrench.

For Poly-V Belt Pulleys.
To Lock The Pulley During Removing Or Assembling
Any Type Of Pulley Retaining Bolt.
Diameter: 40 ~ 140mm.

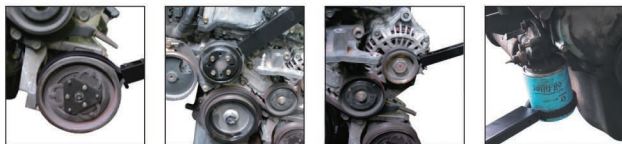

R.R.P. €45.90



9AL12

Pulley Removing Wrench



€69.90

370mm Coil Spring Compressor Set.

Drop Forged SCM435 Jaws & Leaded Screws.
Can Be Used With A 21mm Socket Or A 1/2" Drive Tool.
Suitable Design For Use In Limited Space Under The
Wheel Arch.
Range 85 ~ 370mm.

R.R.P. €85.00



9BF11

Coil Spring Compressor Set



€199

7 Pc. Auto Body Repair Tool Set.

Hammers Are Hardened & Tempered.
Includes 3 Hardwood Handled Hammers & 4 Dollies.
Packed In A Convenient Storage / Carry Case.

R.R.P. €249.00



9CF-307

Auto Body Repair Set

ALL PRICES EXCLUDE VAT AND ARE SUBJECT TO AVAILABILITY • OFFER ENDS 31-12-2012



KING TONY

Spark Plug Boot Pliers.

Safely Removes Spark Plug Cables & Prevents Cable Damage.
Pliers Handle & Jaws Are Coated With A Heavy Duty Plastic For A Secure Grip.

€9.90



R.R.P. €14.90



9DB201

Spark Plug Boot Pliers

6 - 24V Circuit Tester.

Bronze Body Housing.
Cover Cap For Contact Needle.
Interchangeable 24V / 3W Bulb.
Test Voltage 6 ~ 24V.
For The Application Of DC Circuits Only.

€4.90



R.R.P. €5.90



9DC22

Circuit Tester

3 - 48V Automotive Voltage Tester.

Insulated Alligator Clip With 110cm Cable.
2 LED's Indicate
Positive (+) & Negative (-) Polarity.
Test Voltage 3 ~ 48V.
For The Application Of DC Circuits Only.

€8.90



R.R.P. €12.90



9DC23

Voltage Tester

400cc Lever Type Grease Gun.

Ideal For Machinery, Automotive, Agriculture, Recreation Vehicles etc...

Soft Grip On Handle.

Takes Standard Grease Cartridge.

€19.90



R.R.P. €29.90



9BU241

Grease Gun

ALL PRICES EXCLUDE VAT AND ARE SUBJECT TO AVAILABILITY • OFFER ENDS 31-12-2012

• Quality • Service • Reliability • Satisfaction •

The brand you can trust for life



KING TONY

2012 PROMOTION

www.kingtony.ie

Available From:

If no stockist is listed here please call 024 90788 or 086 6028347 for your local stockist.



• Quality • Service • Reliability • Satisfaction •

The brand you can trust for life